

NICD RECHARGEABLE CYLINDRICAL BATTERY

SPECIFICATIONS

Model	:	N170AAAK7BC.1
Description	:	NiCd rechargeable battery, '2/3AAA' size
Nominal Capacity	:	170 mAh at 34mA rate discharge (3 cycles allowed)
Nominal Voltage	:	8.4 Volt (After charge)
Cut-Off Voltage	:	7.0 Volt
End of Charge Voltage	:	≤ 11.2 Volt
End of Discharge Voltage	:	≥ 6.3 Volt
Weight	:	42 gram
Life Duration	:	≥ 500 cycles (Comply to IEC 61951-1 Ed. 2.1 2006)
Charge	:	Trickle - 5.1-8.5 mA Standard - 17 mA x 14 hours Quick - 85 mA x 2.5 hours (with cut-off control)
Temperature Environment	:	Standard charge - 0 degC to 45 degC Quick charge - 10 degC to 40 degC Discharge - -20 degC to 60 degC Storage - -20 degC to 40 degC
Trickle Charge	:	5.1mA for 28 days, no leakage, no explosion
Charge Retention	:	$>60\%$ for 28 days storage after standard charge
Leakage	:	No leakage, No explosion under standard operating condition
Vibration	:	Battery remain normal after vibration at Amp: 4mm; Freq.: 1000/min for 60 min.
Shock	:	Battery remain normal after dropping from 450mm to an Oak board for 3 times

Typical Standard Charge Characteristics (Cylindrical Cell)

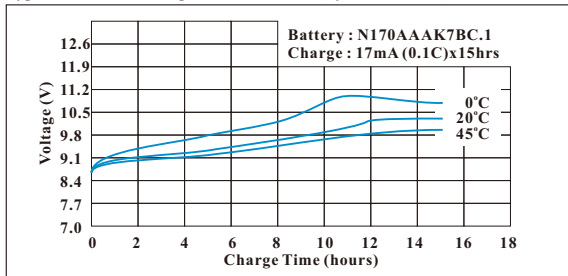

Typical Quick Charge Characteristics (Cylindrical Cell)

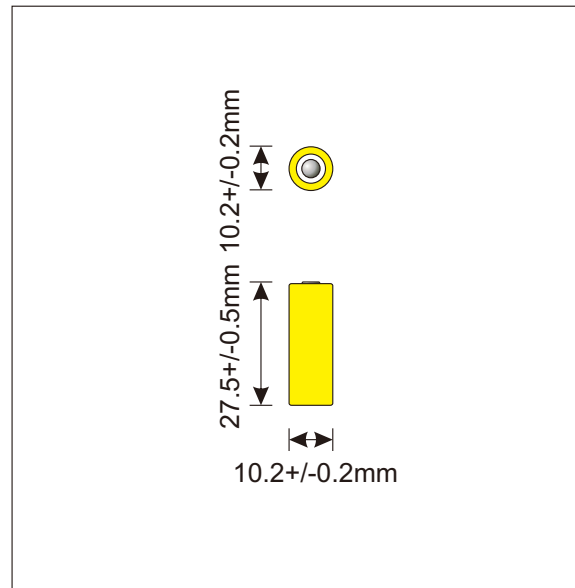
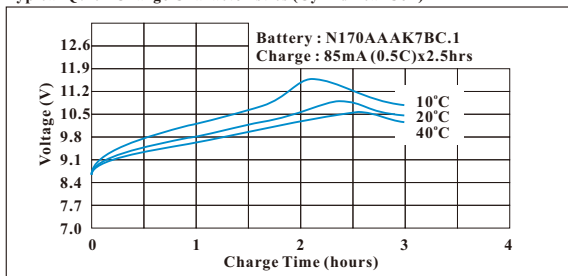

Typical Discharge Characteristics (Cylindrical Cell)

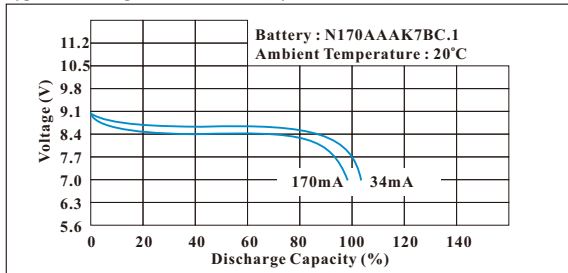

Typical Charge Retention Characteristics (Cylindrical Cell)

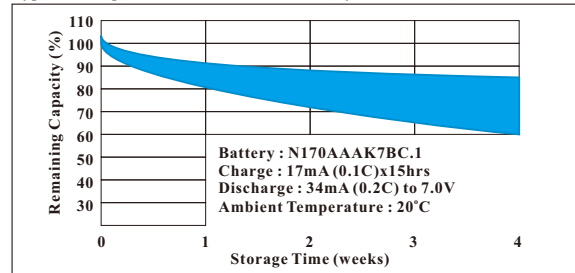

Information is for reference only and is not construed as warranties either expressed or implied, of future performance. Performance varies with time, discharge and storage condition.. 1 year limited guarantee against manufacturing defects. Other problem caused by misuse, mishandling of cell, or malfunction of equipment, is not under the warranty.

Model : N170AAAK7BC.1
Version : 2.50

WELL LINK
INDUSTRIAL LIMITED

E910RA9

NICD RECHARGEABLE CYLINDRICAL BATTERY

DRAWING

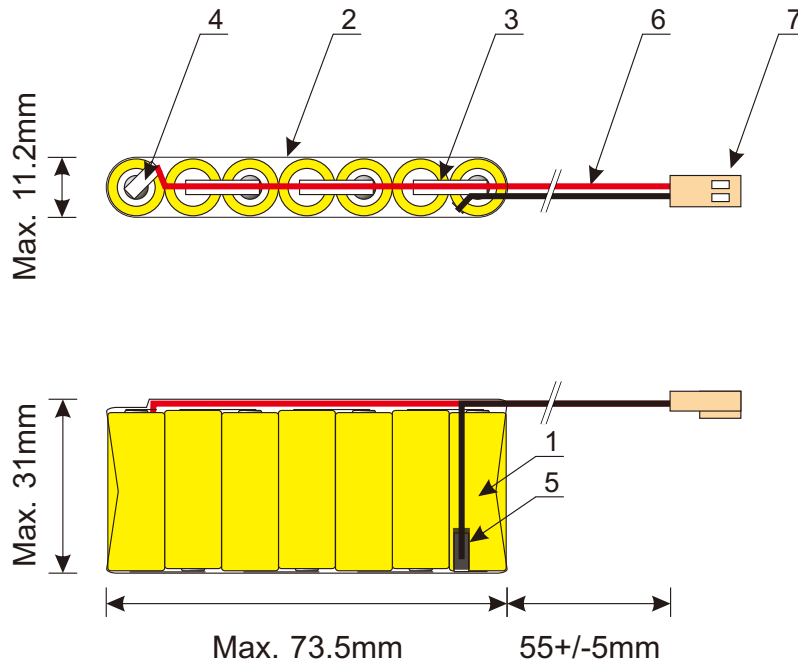

Item	Details	Qty
7	Molex 2510-2P connector or equiv.	1
6	UL1007 AWG#24 B/R Wires	2
5	Shrink Tube	2
4	Soldering Tags (0.13mm)	2
3	Connecting Tags (0.13mm)	6
2	Yellow PVC Shrink	1
1	NiCd 2/3AAA 170mAh Battery	7
Item	Details	Qty

Ink Jet Printing:

KINETIC (Lot:YMMM)
N170AAAK7BC.1
NiCd 8.4V 170mAh

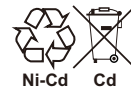

Information is for reference only and is not construed as warranties either expressed or implied, of future performance. Performance varies with time, discharge and storage condition.. 1 year limited guarantee against manufacturing defects. Other problem caused by misuse, mishandling of cell, or malfunction of equipment, is not under the warranty.

Model : N170AAAK7BC.1
Version : 2.50

WELL LINK
INDUSTRIAL LIMITED

E910RA9